



3. In consideration of the payments to be made by the Employer to the Contractor as hereinafter mentioned, the Contractor hereby covenants with the Employer to execute and complete the Works and remedy any defects therein in conformity in all respects with the provisions of the Contract.

- a) Form of Contract
- b) Letter of Acceptance
- c) Form of Tender
- d) Minutes of Negotiation
- e) Special Conditions of Contract
- f) General Conditions of Contract
- g) Drawings
- h) Bill of Quantities
- i) Forms of Securities

2. The following documents shall be deemed to form and be read and construed as part of this Contract. Viz:-

1. In this Contract, words and expressions shall have the same meanings as are respectively assigned to them in the Conditions of Contract hereinafter referred to, and they shall be deemed to form and be read and construed as part of this Contract.

NOW THIS CONTRACT WITNESSETH AS FOLLOWS:

Whereas the Employer is desirous that the Contractor execute REHABILITATION OF LIMALE JUNCTION VIA NDEGERE KIVUKO CHA MKANGIRA ROAD(130KM) IN NYERERE NATIONAL PARK, CONTRACT NO. PA/037/TCRP/2021-2022/HQ/W/25 (hereinafter called "the Works"), and the Employer has accepted the Tender by the Contractor for the execution and completion of such works and the remedying of any defects therein in the sum of Tsh. 741,911,477.20 (Tanzania Shillings Seven Hundred Forty One Million Nine Hundred Eleven Thousand Four Hundred Seventy Seven Cents Twenty Only) VAT Inclusive (hereinafter called "Contract Price").

This Contract made the 31st day of December 2021 between THE TRUSTEES OF THE TANZANIA NATIONAL PARKS OF P.O. BOX 3134 ARUSHA (hereinafter called ("the Employer") and M/S DB SHAPPIYA OF P.O. BOX 3229, DAR ES SALAAM (Hereinafter called "the Contractor") of the other part.

1. Form of Contract

4. The Employer hereby covenants to pay the Contractor in consideration of the execution and completion of the Works and the remedying of defects where in the Contract Price of Tsh. 741,911,477.20 (Tanzania Shillings Seven Hundred Forty One Million Nine Hundred Eleven Thousand Four Hundred Seventy Seven Cents Twenty Only) VAT Inclusive or such other sum as may become payable under the provisions of the Contract at the times and in the manner prescribed by the Contract.
5. The contract duration shall be Six (6) months and the starting date shall be within fourteen days after signing project Execution Form

In Witness whereof the parties thereto have caused this Contract to be executed the day and year first before written.

Sealed with the Common Seal of THE TRUSTEES OF THE TANZANIA NATIONAL PARKS and delivered in our presence this 31st day of December 2021.

Full Name: DR. HUN J. H. KUSAZI
 Signature: [Signature]
 Address: Box 3134
 Designation: ARUSHA COMSERVATION COMMISSIONER

Full Name: [Signature]
 Signature: [Signature]
 Address: 3134 [Signature]
 Designation: [Signature]

Date: 31st December 2021



Sealed with the Common Seal of the M/S DB SHAPRIYA OF P.O.BOX 3229, DAR ES SALAAM and delivered in our presence this 31st day of December 2021.



Full Name: DIPAK KATIK
Signature: 
Address: P.O.Box 3229, DAR ES SALAAM

Designation: Executive Director

Full Name: KRISHDI Praai Mahajan

Signature: 

Address: P.O.Box 3009, DAR ES SALAAM

Designation: Senior QS

Date: 31st December 2021

I. LETTER OF ACCEPTANCE



In reply please quote:

Ref. No. FA.34/347/01

Date: 08.12.2021

Managing Director,
Db Shapriya & Company Limited,
P.O.BOX 3229,
DAR ES SALAAM.

Re: **AWARD NOTIFICATION**

This is to notify you that your tender dated 26th November, 2021, Tender No. PA/037/TCRP/2021-2022/HQ/M/25 for Rehabilitation of Liwale Junction Via Ndegere - Kivuko cha Mkingira(130km) in Nyerere National Park for the Contract Price of Tshs.741,911,477.20 (Tanzania Shillings Seven Hundred Forty One Million Nine Hundred Eleven Thousand Four Hundred Seventy Seven cents Twenty Only) Vat inclusive as corrected and modified in accordance with the instructions to Tenderers is hereby accepted by us.

2. We hereby confirming National Construction Council to be the appointing authority, to appoint the Adjudicator in case of any arisen disputes in accordance with ITT 43.1.
3. You are hereby instructed to proceed with the execution of the said works in accordance with the Contract documents. You are therefore, required to submit Performance Bond and Program of work within fourteen days after signing the contract.
4. Please return the contract dully signed.

Authorized Signature: *[Signature]*
 Name and Title of Signatory: **DR. KILIAN J. H. KIDAZI**
 CONSERVATION COMMISSIONER

Name of Agency: **TANZANIA NATIONAL PARKS.**

II. FORM OF TENDER

25th November 2021

To:
Tanzania National Parks,
P. O. Box 3134,
Arusha.

We D B Shapriya & Co, Ltd, P. O. Box 3229, Dar es Salaam offer to execute the Rehabilitation Of Liwale Junction Via Ndegere - Kivuko Cha Mkanjira Road (130) Km in Nyerere National Park, PA/037/TCRP/2021-2022/HQW/25. in accordance with the Conditions of Contract accompanying this tender for the Contract Price of Tsh. 752,531,477.20 [Tanzania Shillings Seven Hundred Fifty Two Millions, Five Hundred Thirty One Thousand, Four Hundred Seventy Seven and cents Twenty only], inclusive of VAT.

The Contract shall be paid in the following currencies:

Currency	Percentage payable in currency	Rate of exchange: one foreign equals [insert local]	Inputs for which foreign currency is required	(a)	(b)
	100% as per SCC 54.1	1	Not Applicable		

The advance payment required is:-15% of the Total Amount including VAT.

Amount	Currency	(a)	(b)
112,879,721.58	Tsh.		

We declare that our tendering price did not involve contracts with other tenderers for the purpose of tender suppression.

We hereby confirming National Construction Council (NCC) to be the appointing authority, to appoint the adjudicator in case of any arisen disputes in accordance with ITT 43. [Adjudicator]

We are not participating, as tenders, in more than one tender in this tendering process other than alternative tenders in accordance with the tendering documents.

We declare that, as tenderer (s) we do not have conflict of interest with reference to ITT 3.7 [Eligibility of Tenderers]



DB SHAPRIYA & CO LTD

27-28 NYERERE ROAD, P.O.BOX 3229, DAR ES SALAAM, TANZANIA

With reference to ITT 3.11, it is our intention to subcontract approximately [NIL] percentage of the Tender /Contract Price, details of which are provided herein.

Our firm, its affiliates or subsidiaries, including any subcontractors or suppliers for any part of the contract has not been declared ineligible by the Government of the United Republic of Tanzania under Tanzania's laws or any other official regulations.

We declare that our tendering price did not involve contract with other tenderers for the purpose of tender suppression.

This tender and your written acceptance of it shall constitute a binding Contract between us.

We understand that you are not bound to accept the lowest or any tender you receive.

We hereby confirm that this tender complies with the tender validity and tender security required by the tendering documents and specified in the Tender Data Sheet.

Authorized Signature: 

Name and Title of Signatory: Kannan Thyagamoorthy, General Manager - Construction
Name of Tenderer: D B Shapriya & Co, Ltd



Address: 27-28, Nyerere Road, P. O. Box 3229, Dar es Salaam, Tanzania

III. MINUTES OF NEGOTIATION

TANZANIA NATIONAL PARKS



MINUTES OF NEGOTIATION MEETING OF TENDER NA:
PA/037/TCRP/2021-2022/HQ/W/25. : REHABILITATION OF LIMALE
JUNCTION VIA NDEGERE-KIVUKO CHA MKANGIRA (130KM) IN
NYERERE NATIONAL PARK..

1.0 Venue: TANAPA Board room

2.0 Present:

- | | | |
|--|----------------------|-------------|
| i. Elisonguo Malisa | CO II-Infrastructure | Chairperson |
| ii. Haruna Mtembe | CR II-PMU | Secretary |
| iii. Angel Lyanga | SCA-Accounts | Member |
| iv. Dirak Kotail | CO-D.B Shapria | Member |
| v. Kannan Thyagamoorthy GM-D.B Shapria | | Member |

3.0 Opening:

The Chairman called the meeting to order at 13:10HRS by welcoming the members and the Contractor.

4.0 Adoption of the Agenda:

The committee adopted the agenda as follows:-

Agenda.

1. Price reduction
2. Contract duration

5.0 Price reduction

The negotiation team agreed to reduce the quoted price in the bidding document from Tsh. 752,531,477.20 to Tsh. 741,911,477.20 VAT Inclusive as shown in the attached revised Bills of Quantities (BOQ).

6.0. Delivery schedule.

The team agreed the duration of the contract remain the same 6 Months. There being no any other agenda to discuss the meeting was closed at 13:55HRS

ON BEHALF OF CLIENT

[Signature]
Jeremiah Mawungu

Date: 03/12/2021



[Signature]
Dipak K. Saha

ON BEHALF OF CONTRACTOR

IV. SPECIAL CONDITIONS OF CONTRACT

Special Conditions of Contract (SCC)

The following Special Conditions of Contract shall supplement the General Conditions of Contract. Whenever there is a conflict, the provisions herein shall prevail over those in the General Conditions of Contract. Except where otherwise indicated, all Special Conditions of Contract should be filled in by the Employer prior to issuance of the Tendering Documents. Schedules and reports to be provided by Employer should be annexed.

GCC Clause	SCC Clause	Description
1	1.1	<p>A. General</p> <p>The Employer is The Trustees of the Tanzania National Parks P.O. Box 3134, Arusha.</p> <p>The Adjudicator is National Construction Council</p> <p>The Defects Liability Period is 180 days.</p> <p>The Project Manager is to be appointed</p> <p>The Works consist of</p> <p style="margin-left: 20px;">1. Road Works</p> <p style="margin-left: 20px;">2. Drainage Works:</p> <p>The Start Date shall be within Fourteen (14) Days after Signing Project Execution Form.</p> <p>The Intended Completion Date for the whole of the Works shall be Six months after the start date</p> <p>The Site is located at Nyerere National Park.</p>
2.	2.2	Indicate whether sectional completion is specified: Not Specified
3.	2.3(10)	List other documents that form part of the contract if any: Project Execution Form
4.	4.1	The language of the Contract documents is English The law that applies to the Contract is "The Laws of Tanzania."
5	8.1	Address for communication Employer's Tanzania National Parks, P.O. Box 3134 Arusha E-mail: cc@tanzaniaparks.go.tz , psm@tanzaniaparks.go.tz

Contractor's M/S DB SHAPRIYA & COMPANY LIMITED P.O.BOX 3229 DAR ES SALAAM	6.	12.1	Include the Schedule of Other Contractors, if any. Not Applicable
	7.	13.1	Include the Schedule of Key Personnel. a) Project manager b) Site engineer c) Site foreman
	8.	17.1	The minimum insurance covers shall be: (a) loss of or damage to the Works, Plant, and Materials shall be 80% of the contract sum (b) loss of or damage to Equipment shall be 15% of the contract sum. (c) loss of or damage to property (except the Works, Plant, Materials, and Equipment) in connection with the Contract shall be 10% of the contract sum and (d) Personal injury or death shall be 15% of the contract sum.
	9.	18.1	Site Investigation Reports available to the Tenderer are Not Applicable
		25.1	Unless otherwise, state tax payment status: Not Applicable
	10.	26.4	The other measures include: a. Minimizing the number of migrant workers employed on the project and household in the site camp b. Providing access to voluntary counseling and testing (VCT) c. Providing psychological support and health care including prevention and treatment of opportunistic infections for workers infected and affected, as well as their families d. Providing condoms (male and female) to workers
	11.	28.1	The Site Possession Date shall be within fourteen days (14days) after the contract has come into Effect.
	12.	32.2	If either Party is dissatisfied with the Adjudicator's decision may, refer the dispute for arbitration within fourteen working days

13	31.1	Appointing Authority for the Adjudicator: National Construction Council
14.	32.3	Arbitration will take place at Arusha in accordance with rules and regulations published by National Construction Council using arbitration rules 2001 edition and National Construction Council adjudication procedural rules 2017.
15.	35.1	The responsible person for security of the site: - refer GCC 35
B. Time Control		
16.	36.1	The Contractor shall Submit a Programme for the Works within 14 days of delivery of the Letter of Acceptance.
17.	36.2	The period between Programme updates is 30 days.
18.	36.2	The amount to be withheld by the Project Manager in the case the contractor does not submit an updated programme is: Tshs. 100,000.00
C. Quality Control		
19.	44.1	The Defects Liability Period is 180 days.
D. Cost Control		
20	52.7	Minimum Amount of Interim Payment Certificate will be 10% of Contract price
21	54.1	The currency of payment shall be Tanzanian Shillings
22.	57	The contract is not subject to price adjustment.
23.	58.1	The amount of retention is 10% of value of works of Interim Payment Certificate', Limit of retention will be 5% of Contract Price.
24.	59.1	The amount of liquidated damages 0.1% Of Contract Price Per Day
24.	60.1	The maximum amount of liquidated damages must be equivalent to the amount of the performance security 10% of the contract price
25.	60.1	The bonus for early completion is Zero per day.
26.	61.1	The amount of advance payment shall be (15%) fifteen per cent of the contract sum payable within 30 days from the

			date of submission of bank guarantee
			Monthly Recovery of Advance Payment shall be in three (3) installments: i.e., 30%, 30% and 40% of Advance Payment respectively
27.	62.1		The Performance Security shall be: 10% of the contract price.
28	66.1		Contractor shall handover the site and the works to the Employer within 28 days after practical completion Certificate.
			E. Discharge of the Contract
29.	68.1		As built drawings shall be supplied by the contractor within 28 days after completion
			Operating manual shall be supplied by the contractor by Not Applicable
30.	68.2		The amount to be withheld by the Project Manager in the case the contractor does not submit as built drawings is: Tshs. 500,000.00
			The amount to be withheld by the Project Manager in the case the contractor does not submit operating manual is: Not Applicable
31.	69.2 (i)		Number of days for which the maximum amount of liquidated damages can be paid is 100 days
32.	70.1		The percentage to apply to the value of the work not completed, representing the Employer's additional cost for completing the Works, is 0.1 percent

V. GENERAL CONDITIONS OF CONTRACT

1. Definition

A. General

The following words and expressions shall have the meanings hereby assigned to them:

The **Adjudicator** is the person appointed by the appointing Authority specified in the Special Conditions of Contract (SCC), to resolve contractual disputes in the first instance, and as provided for in **GCC 31 and 32** hereunder.

The **Arbitrator** is the person appointed to resolve contractual disputes, and as provided for in **GCC 32** hereunder.

Bill of Quantities means the priced and completed Bill of Quantities forming part of the Tender.

Compensation Events are those events provided for in **GCC 55**.

The **Completion Date** is the date of completion of the Works as certified by the Project Manager, in accordance with **GCC 21.1**

The **Commencement Date** is the date when the Contractor shall commence execution of the Works as specified in the **Notice of Contract Commencement**. The Commencement Date may be revised by the Project Manager in consultation with the employer by issuing an extension of time.

The **Contract** is the Contract entered between the Employer and the Contractor to execute, complete, and maintain the Works. It consists of the documents listed in **GCC 2.3** below.

The **Contractor** is a person whether natural or legal whose Tender to carry out the Works has been accepted by the Employer.

The **Contractor's Tender** is the completed tendering document submitted by the Contractor to the Employer.

The **Contract Price** is the price stated in the Letter of Acceptance and thereafter as adjusted in accordance with the provisions of the Contract.

Days are calendar days; **Months** are calendar

months.

Dayworks are varied work inputs subject to payment on a time basis for the Contractor's employees and Equipment, in addition to payments for associated Materials and Plant.

A Defect is any part of the Works not completed in accordance with the Contract.

The Defects Liability Certificate is the certificate issued by Project Manager upon correction of defects by the Contractor.

The Defects Liability Period is the period named in the SCC and calculated from the Completion Date.

Drawings means the drawings of the works, as included in the contract and any additional or modified drawings issued by (or on behalf of) the Employer in accordance with the contract.

Effective Contract date is the date shown in the notice of Contract Commencement issued by the Employer upon fulfillment of the conditions precedent stipulated in Clause 3 of the GCC.

The Employer is the person named as employer in the SCC and the legal successors in title to this person.

Equipment is the Contractor's machinery and vehicles brought to the Site to execute the Works.

Force Majeure means an unforeseeable event which is beyond reasonable control of either Party and which makes a Party's performance of its obligations under the Contract impossible or so impractical as to be considered impossible under the circumstances.

For the purposes of this Contract, "Force Majeure" means an event which is beyond the reasonable control of a Party, is not foreseeable, is unavoidable, and its origin is not due to negligence or lack of care on the part of a Party, and which makes a Party's performance of its obligations hereunder impossible or so impractical as reasonably to be considered impossible in the circumstances; and includes, but is not limited to, war, riots, civil disorder, earthquake,

fire, explosion, storm, flood, epidemics, or other adverse weather conditions, strikes, lockouts or other industrial action (except where such strikes, lockouts or other industrial action are within the power of the Party invoking Force Majeure to prevent), confiscation.

The **Intended Completion Date** is the date on which it is intended that the Contractor shall complete the Works. The **Intended Completion Date** is specified in the **SCC**. The **Intended Completion Date** may be revised only by the Project Manager by issuing an extension of time or an acceleration order.

Materials are all supplies, including consumables, used by the Contractor for execution of the Works.

Plant is any integral part of the Works that shall have a mechanical, electrical, chemical, or biological function.

The **Project Manager** is the person named in the **SCC** (or any other competent person appointed by the Employer and notified to the Contractor, to act in replacement of the Project Manager) who is responsible for supervising the execution of the Works and administering the Contract.

The **Site** is the area where works are to be executed as specified in the **SCC**.

Site Investigation Reports are factual and interpretative reports about the surface and subsurface conditions at the Site that were included in the Tendering documents as indicated in the **SCC**.

Specification means the Specification of the Works included in the Contract and any modification or addition made or approved by the Project Manager.

The **Start Date** is given in the **SCC**. It is the latest date when the Contractor shall commence execution of the Works. It does not necessarily coincide with any of the Site Possession Dates.

A **Subcontractor** is a person whether natural or legal who has a Contract with the Contractor to carry out a part of the work in the Contract, which

	<p>includes work on the Site.</p> <p>Temporary Works are works designed, constructed, installed, and removed by the Contractor that are needed for construction or installation of the Works.</p> <p>A Variation is an instruction given by the Project Manager in consultation with the Employer, that varies the Works.</p> <p>The Works are what the Contract requires the Contractor to construct, install, and turn over to the Employer, as defined in the SCC.</p>
--	--

<p>2.1 In interpreting these Conditions of Contract headings and marginal notes are used for convenience only and shall not affect their interpretations unless specifically stated; references to singular include the plural and vice versa; and masculine include the feminine. Words have their ordinary meaning under the language of the Contract unless specifically defined.</p> <p>2.2 If sectional completion is specified in the SCC, references in the Conditions of Contract to the Works, the Completion Date, and the Intended Completion Date apply to any Section of the Works (other than references to the Completion Date and Intended Completion Date for the whole of the Works).</p> <p>2.3 The documents forming the Contract shall be interpreted in the following order of priority:</p> <ol style="list-style-type: none"> (1) Form of Contract, (2) Special Conditions of Contract, (3) General Conditions of Contract, (4) Letter of Acceptance, (5) Certificate of Contract Commencement, (6) Specifications, (7) Drawings, (8) Bill of Quantities, (9) Contractor's Tender, and (10) Any other document listed in the Special Conditions of Contract as forming part of the Contract. 		<p>2. Interpretation</p>
--	--	--------------------------

<p>3.1 Having signed the Contract, it shall come into effect on the date on which the following conditions have been satisfied:-</p> <p>a) Submission of performance Security in the form specified in the SCC; and</p> <p>b) Furnishing of Unconditional Advance Payment Guarantee.</p> <p>3.2 If the Conditions precedent stipulated on GCC 3.1 is not met by the date specified in the SCC this contract shall not come into effect;</p> <p>3.3 If the Employer is satisfied that each of the conditions precedent in this contract has been satisfied (except to the extent waived by him, but subject to such conditions as he shall impose in respect of such waiver) he shall promptly issue to the contractor a certificate of Contract commencement, which shall confirm the start date.</p>		<p>3. Conditions Precedent</p>
<p>4.1 The language of the Contract and the law governing the Contract are stated in the SCC.</p>		<p>4. Language and Law</p>
<p>5.1 The Service Providers, their Subcontractors, and the Personnel of either of them shall not disclose any proprietary or confidential information relating to the Project, the Services, this Contract, or the Employer's business or operations without the prior written consent of the Employer.</p>		<p>5. Confidentiality</p>
<p>6.1 Except where otherwise specifically stated, the Project Manager will supervise execution of the contract between the Employer and the Contractor. The Project Manager shall have no authority to amend the contract.</p>		<p>6. Project Manager's role</p>
<p>7.1 The Project Manager may upon prior consent of the employer and after notifying the contractor, delegate any of his duties and responsibilities to other people except to the Adjudicator, and may cancel any delegation after notifying the Contractor.</p>		<p>7. Delegation</p>

<p>8.1 Communications between the Parties to the Contract shall be effective only when in writing whether in hard or electronic form that provides record of the content of the communication. A notice shall be effective only when it is delivered at the address specified in the SCC.</p>		<p>8. Communications</p>
<p>9.1 The Contractor may subcontract with the approval of the Project Manager, subject to consultation with the Employer. Subcontracting shall not alter the Contractor's obligations.</p>		<p>9. Subcontracting</p>
<p>10.1 The Contractor shall not assign, transfer, pledge or make other disposition of this Contract or any part thereof, or any of the Contractor's rights, claims or obligations under this Contract except with the prior written consent of the Employer.</p>		<p>10. Assignment</p>
<p>11.1 If the Contractor constitutes a joint venture, consortium or other unincorporated grouping of two or more persons: (a) These persons shall be jointly and severally liable to the Employer for the performance of the Contract; (b) These person shall notify the Employer of their leader who shall have the authority to bind the Contractor and each of these persons; and (c) The Contractor shall not alter its composition or legal status without the prior consent of the Employer.</p>		<p>11. Liability of Joint Venture</p>
<p>12.1 The Contractor shall cooperate and share the Site with other contractors, public authorities, utilities, and the Employer between the dates given in the Schedule of Other Contractors, as referred to in the SCC. The Contractor shall also provide facilities and services for them as described in the Schedule. The Employer may modify the Schedule of Other Contractors, and shall notify the Contractor of any such modification</p>		<p>12. Other Contractors</p>

<p>13.1 The Contractor shall employ the key personnel named in the Schedule of Key Personnel, as referred to in the SCC, to carry out the functions stated in the Schedule or other personnel approved by the Project Manager. The Project Manager will approve any proposed replacement of key personnel only if their relevant qualifications and abilities are substantially equal to or better than those of the personnel listed in the Schedule.</p> <p>13.2 If the Project Manager asks the Contractor to remove a person who is a member of the Contractor's staff or work force, stating the reasons for, the Contractor shall ensure that the person leaves the Site within seven days and has no further connection with the work in the Contract.</p>		<p>13. Personnel</p>
<p>14.1 The Employer carries the risks which this Contract states are Employer's risks, and the Contractor carries the risks which this Contract states are Contractor's risks.</p>		<p>14. Employer's and Contractor's Risks</p>

<p>15.1 From the Start Date until the Defects Correction Certificate has been issued, the following are Employer's risks:</p> <p>(a) The risk of personal injury, death, or loss of or damage to property (excluding the Works, Plant, Materials, and Equipment), which are due to</p> <p>(i) use or occupation of the Site for the purpose of the Works, which is the unavoidable result of the Works or</p> <p>(ii) negligence, breach of statutory duty, or interference with any legal right by the Employer or by any person employed by or contracted to him except the Contractor.</p> <p>(b) The risk of damage to the Works, Plant, Materials, and Equipment to the extent that it is due to a fault of the Employer or in the Employer's design,</p> <p>15.2 From the Completion Date until the Defects Correction Certificate has been issued, the risk of loss of or damage to the Works, Plant, and Materials is an Employer's risk except loss or damage due to</p> <p>(i) a Defect which existed on the Completion Date,</p> <p>(ii) an event occurring before the Completion Date, which was not itself an Employer's risk, or</p> <p>(iii) the activities of the Contractor on the Site after the Completion Date.</p>		<p>15. Employer's Risks</p>
<p>16.1 From the Starting Date until the Defects Correction Certificate has been issued, the risks of personal injury, death, and loss of or damage to property (including, without limitation, the Works, Plant, Materials, and Equipment) which are not Employer's risks are Contractor's risks.</p>		<p>16. Contractor's Risks</p>

<p>17.1 The Contractor shall provide, in the joint names of the Employer and the Contractor, insurance cover from the Start Date to the end of the Defects Liability Period, in the amounts and deductibles stated in the SCC for the following events which are due to the Contractor's risks:</p> <p>(a) loss of or damage to the Works, Plant, and Materials;</p> <p>(b) loss of or damage to Equipment;</p> <p>(c) loss of or damage to property (except the Works, Plant, Materials, and Equipment) in connection with the Contract; and</p> <p>(d) personal injury or death.</p> <p>17.2 Policies and certificates for insurance shall be delivered by the Contractor to the Project Manager for the Project Manager's approval before the Start Date. All such insurance shall provide for compensation to be payable in the types and proportions of currencies required to rectify the loss or damage incurred.</p> <p>17.3 If the Contractor does not provide any of the policies and certificates required, the Employer may effect the insurance which the Contractor should have provided and recover the premiums the Employer has paid from payments otherwise due to the Contractor or, if no payment is due, the payment of the premiums shall be a debt due.</p> <p>17.4 Alterations to the terms of insurance shall not be made without the approval of the Project Manager.</p> <p>17.5 Both parties shall comply with any conditions of the insurance policies.</p>		<p>17. Insurance</p>
<p>18.1 The Contractor shall, in executing the contract, rely on Site Investigation Reports referred to in the SCC and any supplemented information available to the Contractor.</p>		<p>18. Site Investigation Reports</p>
<p>19.1 The Project Manager will clarify queries on all contractual matters.</p>		<p>19. Queries about Implementation of Contract</p>

<p>20.1 The Contractor shall execute and install the Works in accordance with the Terms and Conditions of Contract.</p>		<p>20. Contractor to execute the Works</p>
<p>21.1 The Contractor may commence execution of the Works on the Start Date and shall carry out the Works in accordance with the Works Programme submitted by the Contractor, as updated with the approval of the Project Manager, and complete them by the Intended Completion Date.</p>		<p>21. Commencement and Completion of the Works</p>
<p>22.1 The Contractor shall submit Specifications and Drawings showing the proposed Temporary Works to the Project Manager, who is to approve them if they comply with the Specifications and Drawings.</p> <p>22.2 The Contractor shall be responsible for design of Temporary Works.</p> <p>22.3 The Project Manager's approval shall not alter the Contractor's responsibility for design of the Temporary Works.</p> <p>22.4 The Contractor shall obtain approval of third parties to the design of the Temporary Works, where required.</p> <p>22.5 All Drawings prepared by the Contractor for the execution of the temporary or permanent Works, are subject to prior approval by the Project Manager before their use.</p>		<p>22. Approval by the Project Manager</p>
<p>23.1 The Contractor shall take all reasonable steps to protect the environment and to limit damage and nuisance to people and property resulting from pollution, noise and other results of his operations.</p>		<p>23. Protection of the Environment</p>
<p>23.2 The Contractor shall ensure that emissions, surface discharges and effluent from his activities shall not exceed limits prescribed in relevant environmental laws.</p>		

<p>24.1 The Contractor shall comply with all the relevant labour laws applicable in the Country, including laws relating to workers employment, working hours, health, safety, welfare, immigration and shall allow them all their legal rights.</p> <p>24.2 The Contractor shall require his employees to obey all applicable laws, including those concerning safety at work.</p>		<p>24. Labour Laws</p>
<p>25.1 The Contractor, Sub-contractors and Personnel shall pay such taxes, duties, fees and other impositions as may be levied under the Laws of Tanzania unless otherwise stated in the SCC.</p>		<p>25. Taxes and Duties</p>
<p>26.1 The Contractor shall at all times take all reasonable precautions to maintain the health and safety of his personnel and the public as per the governing occupational, health and safety laws.</p>		<p>26 Health and Safety</p>
<p>26.2 The Contractor shall ensure that first aid facilities are available at all times at the site and that suitable arrangements are made for all necessary welfare and hygiene requirements and for the prevention of epidemics.</p> <p>26.3 The Contractor shall notify the Employer details of any accident as soon as practicable after its occurrence. The Contractor shall maintain records and make reports concerning health, safety, and welfare of persons, and damage to the property, as the Employer may reasonably require.</p> <p>26.4 The Contractor shall conduct an HIV-Aids awareness programme, and shall take other such measures as specified in the SCC to reduce the risk of transfer of HIV virus between and among Contractor personnel, the Employers Staff and the surrounding community.</p>		

<p>27.1 Anything of historical or other interest or of significant value unexpectedly discovered on, in, or under the land at the Site shall be the property of the Employer. The Contractor shall notify the Project Manager of such discoveries and carry out the Project Manager's instructions for dealing with them.</p>		<p>27 Discoveries</p>
<p>28.1 The Employer may give possession of whole or parts of the Site to the Contractor as stated in the SCC. If possession is not given by the date stated in the SCC, the Employer will be deemed to have delayed the start of the relevant activities, and this may be a Compensation Event.</p>		<p>28 Possession of the Site</p>
<p>29.1 The Contractor shall allow the Project Manager and any person authorized by the Project Manager access to the Site and to any place where work in connection with the Contract is being carried out or is intended to be carried out.</p>		<p>29 Access to the Site</p>
<p>30.1 The contractor shall comply with instructions given by the Project Manager in writing on any matter related to the contract which comply with the applicable laws where the Site is located.</p> <p>30.2 The Contractor shall permit the Government of the United Republic of Tanzania to inspect the Contractor's accounts and records relating to the performance of the Contractor and to have them audited by auditors appointed by the Government of the United Republic of Tanzania, if so required by the Government of the United Republic of Tanzania</p>		<p>30 Instructions, Audits</p>
<p>31.1 In the event of any dispute arising out of this contract, either party shall issue a notice of dispute to settle the dispute amicably. The parties hereto shall, within twenty eight (28) days from the notice date, use their best efforts to settle the dispute amicably through mutual consultations and negotiation. Any unsolved dispute may be referred by either party to an adjudicator nominated by the appointing Authority specified in SCC.</p>		<p>31 Disputes Resolution</p>

<p>32.1 After the dispute has been referred to the adjudicator, within 30 days, or within such other period as may be proposed by the Parties, the rendered Adjudicator shall give its decision. The rendered decision shall be binding to the Parties.</p> <p>32.2 If either Party is dissatisfied with the Adjudicator's decision may, within days specified in the SCC refer the dispute for arbitration. If either party within the period mentioned in the SCC has not referred the matter for arbitration the decision shall become final and binding to the Parties.</p>		
<p>32.3 The arbitration shall be conducted in accordance with the arbitration procedure published by the institution named and in the place shown in the SCC.</p>		<p>32 Procedure for disputes</p>

<p>33.1 The rate of the Adjudicator's fee and administrative costs of adjudication shall be borne equally by the Parties. The rates and costs shall be in accordance with the rules of the Appointing Authority. In conducting adjudication to its finality each party shall bear its incurred costs and expenses.</p>		<p>33 Fees and Costs of Adjudicator</p>
<p>34.1 Should the Adjudicator resign or die, or should the Employer and the Contractor agree that the Adjudicator is not functioning in accordance with the provisions of the Contract, a new Adjudicator will be appointed by the Appointing Authority.</p>		<p>34 Replacement of Adjudicator</p>
<p>35.1 Unless otherwise stated in the SCC, (a) the Contractor shall be responsible for keeping unauthorised persons off the site, and (b) authorised persons shall be limited to the Contractor's and Employer's personnel, and to any other personnel and other Contractor notified to the Contractor by the Project Manager or Employer.</p>		<p>35 Security of the Site</p>
<p>B. Time Control</p>		
<p>36.1 Within the time stated in the SCC, the Contractor shall submit to the Project Manager for approval of a Work Programme showing the method(s), arrangements, order, and timing for all the activities of the Works.</p>		<p>36 Programme</p>
<p>36.2 The Contractor shall submit to the Project Manager for approval an updated Works Program at intervals not longer than the period stated in the SCC. If the Contractor does not submit an updated Works Program within this period, the Project Manager may withhold the amount stated in the SCC from the next payment certificate and continue to withhold this amount until the next payment after the date on which the overdue Program has been submitted.</p>		

<p>36.3 An update of the Works Program shall be a program showing the actual progress achieved on each activity and the effect of the progress achieved on the timing of the remaining work, including any changes to the sequence of the activities.</p>		
<p>36.4 The Project Manager's approval of the Programme shall not alter the Contractor's obligations. The Contractor may revise the Programme and submit it to the Project Manager again at any time. A revised Programme shall show the effect of Variations and Compensation Events</p>		
<p>37.1 The Employer may extend the Intended Completion Date if a Compensation Event occurs or a Variation is issued which makes it impossible for Completion to be achieved by the Intended Completion Date without the Contractor taking steps to accelerate the remaining work, which would cause the Contractor to incur additional cost.</p>		<p>37 Extension of the Intended Completion Date</p>
<p>37.2 The Employer shall, within twenty one (21) days of receipt of application for extension of the Intended Completion Date by the Contractor, decide whether or not to grant the extension. The application by the Contractor shall be granted only when supported by full information of a compensation event(s) or variation.</p>		
<p>37.3 In the event the Contractor has not issued an early warning notice of a delay or has failed to cooperate in dealing with a delay, such a delay or failure may be a ground for not granting the extension of the Intended Completion Date</p>		

<p>38.1 When the Employer wants the Contractor to finish the works before the Intended Completion Date, the Project Manager will obtain priced proposals for achieving the necessary acceleration from the Contractor. If the Employer accepts the said proposals, the Intended Completion Date will be adjusted accordingly and confirmed by both the Employer and the Contractor.</p> <p>38.2 In the event that the Contractor's priced proposals for an acceleration of the Works are accepted by the Employer, they shall be incorporated in the Contract Price and treated as a Variation.</p>		<p>38 Acceleration</p>
<p>39.1 The Project Manager may instruct the Contractor to delay the start or progress of any activity within the Works</p> <p>39.2 During such suspension, the Contractor shall protect, store and secure such part or the Works against any deterioration, loss or damage.</p> <p>39.3 The Project Manager may also notify the cause for the suspension.</p>		<p>39 Delays Ordered by the Project Manager</p>
<p>40.1 Either the Project Manager or the Contractor may require the other to attend a management meeting. The business of a management meeting shall be to deal with matters raised in accordance with the early review the plans for remaining work and to deal with matters raised in accordance with the early warning procedure.</p> <p>40.2 The Project Manager shall record the business of management meetings and provide copies of the record to those attending the meeting and to the Employer. The responsibility of the parties for actions to be taken shall be decided by the Project Manager either at the management meeting or after the management meeting and stated in writing to all who attended the meeting.</p>		<p>40 Management Meetings</p>

<p>41.1 The Contractor shall warn the Project Manager at the earliest opportunity of specific likely future event(s) or circumstance(s) that may adversely affect the quality of the Works, increase the Contract Price or delay the execution of the Works. Upon receipt of the said Notice, the Project Manager may require the Contractor to provide an estimate of the expected effect of the future event(s) or circumstance(s) on the Contract Price and Intended Completion Date or Completion Date as the case may be. The estimate shall be provided by the Contractor as soon as reasonably possible.</p> <p>41.2 The Contractor shall cooperate with the Project Manager in making and considering proposals for how the effect of such an event(s) or circumstance(s) can be avoided or reduced by anyone involved in the Works and in carrying out any resulting Instruction of the Project Manager.</p>	<p>C. Quality Control</p>	<p>41 Early Warning Notice</p>
---	---------------------------	------------------------------------

<p>42.1 The Project Manager shall check the Contractor's work and notify the Contractor of any Defects that are found. Such checking shall not affect the Contractor's responsibilities.</p> <p>42.2 The Project Manager may instruct the Contractor to search for a Defect and to uncover and test any work that the Project Manager considers may have a Defect.</p>		<p>42 Identifying Defects</p>
<p>43.1 The Project Manager may instruct the Contractor to carry out a test not specified in the Specification to check whether any work has a Defect and in the event the test shows that it does, the Contractor shall pay for the test and any samples thereof. If there is no Defect, the test shall be a Compensation Event.</p>		<p>43 Tests</p>
<p>44.1 The Project Manager shall give notice to the Contractor of any Defects before the end of the Defects Liability Period stated in the SCC, which begins from the Completion date.</p> <p>44.2 Every time notice of a Defect is given, the Contractor shall correct the notified Defects within the period of time specified in the Project Manager's notice.</p> <p>44.3 If the Contractor has not corrected a defect within the time specified in the Employer's notice, a penalty for lack of performance will be paid by the Contractor. The amount to be paid will be calculated as a percentage of the cost of having the defect corrected, assessed as described in GCC 46.1.</p>		<p>44 Correction of Defects</p>
<p>45.1 The Defects Liability Period may be extended by the Project Manager for as long as Defects remain to be corrected.</p>		<p>45 Extension of Defect Liability Period</p>
<p>46.1 In the event the Contractor has not corrected a Defect(s) within the time specified in the Project Manager's notice, the Project Manager will assess the cost of having the Defect corrected, including any other related cost(s) and the Contractor will pay the said cost.</p>		<p>46 Uncorrected Defects</p>

<p>D. Cost Control</p>		
<p>47.1 The Bill of Quantities shall contain items for the construction, installation, testing, and commissioning work to be done by the Contractor.</p> <p>47.2 The Bill of Quantities is used to calculate the Contract Price. The Contractor shall be paid for the quantity of the work done at the rate in the Bill of Quantities for each item.</p>		<p>47 Bill of Quantities</p>
<p>48.1 If the final quantity of the work done differs from the quantity in the Bill of Quantities for the particular item by more than 25 percent, provided the change exceeds 1 percent of the Initial Contract Price, the Project Manager shall adjust the rate to allow for the change.</p> <p>48.2 The Project Manager shall not adjust rates from changes in quantities if thereby the Initial Contract Price is exceeded by more than 15 percent, except with the prior approval of the Employer.</p> <p>48.3 If requested by the Project Manager, the Contractor shall provide the Project Manager with a detailed cost breakdown of any rate in the Bill of Quantities.</p>		<p>48 Changes in the Quantities</p>
<p>49.1 All Variations shall be included in updated Work Programmes produced by the Contractor.</p>		<p>49 Variations</p>

<p>51.1 When the Works Programme is updated, the Contractor shall provide the Project Manager with an updated cash flow forecast. The cash flow forecast shall include different currencies, as defined in the Contract, converted as necessary using the Contract exchange rates.</p>		<p>51 Cash Flow Forecasts</p>
<p>50.1 The Contractor shall provide the Project Manager with a quotation for carrying out the Variation when requested to do so by the Project Manager. The Project Manager shall assess the quotation, which shall be given within seven days of the request or within any longer period stated by the Project Manager and before the Variation is ordered.</p> <p>50.2 If the work in the Variation corresponds with an item description in the Bill of Quantities and if, in the opinion of the Project Manager, the quantity of work is above the limit stated in Sub-Clause 48.1 or the timing of its execution do not cause the cost per unit of quantity to change, the rate in the Bill of Quantities shall be used to calculate the value of the Variation. If the cost per unit of quantity changes, or if the nature or timing of the work in the Variation does not correspond with items in the Bill of Quantities, the quotation by the Contractor shall be in the form of new rates for the relevant items of work.</p> <p>50.3 If the Contractor's quotation is unreasonable, the Project Manager may order the Variation and make a change to the Contract Price, which shall be based on the Project Manager's own forecast of the effects of the Variation on the Contractor's costs.</p> <p>50.4 If the Project Manager decides that the urgency of varying the work would prevent a quotation being given and considered without delaying the work, no quotation shall be given and the Variation shall be treated as a Compensation Event.</p> <p>50.5 The Contractor shall not be entitled to additional payment for costs that could have been avoided by giving early warning Notice.</p>		<p>50 Payments for Variations</p>

<p>52.1 The Contractor shall submit to the Project Manager monthly statements of the estimated value of the work executed less the cumulative amount certified previously.</p> <p>52.2 The Project Manager shall check the Contractor's monthly statement and certify the amount to be paid to the Contractor within twenty eight (28) days of receipt of the certificate from the contractor.</p> <p>52.3 The value of work executed shall be determined by the Project Manager.</p> <p>52.4 The value of work executed shall comprise the value of the quantities of the items in the Bill of Quantities completed.</p> <p>52.5 The value of work executed shall include the valuation of Variations and Compensation Events.</p> <p>52.6 The Project Manager may exclude any item certified in a previous certificate or reduce the proportion of any item previously certified in any certificate in the light of later information.</p> <p>52.7 The Project Manager shall not be bound to certify any payment, if the net amount, after all retentions and deductions would be less than minimum amount of Interim Payment Certificate stated in the SCC.</p>		<p>52 Payment Certificates</p>
--	--	--------------------------------

<p>53.1 Payments shall be adjusted for deductions for advance payments and retention. The Employer shall pay the Contractor the amounts certified by the Project Manager within 28 days of the date of each certificate. If the Employer makes a late payment, the Contractor shall be paid interest on the late payment in the next payment. Interest shall be calculated from the date by which the payment should have been made up to the date when the late payment is made at the prevailing rate of interest issued by the Bank of Tanzania on the date of Contract signature for each of the currencies in which payments are made.</p> <p>53.2 If an amount certified is increased in a later certificate or as a result of an award by the Adjudicator or an Arbitrator, the Contractor shall be paid interest upon the delayed payment as set out in this clause. Interest shall be calculated from the date upon which the increased amount would have been certified in the absence of dispute.</p> <p>53.3 Unless otherwise stated, all payments and deductions will be paid or charged in the proportions of currencies comprising the Contract Price.</p> <p>53.4 Items of the Works for which no rate or price has been entered in will not be paid for by the Employer and shall be deemed covered by other rates and prices in the Contract.</p>		<p>53 Payments</p>
<p>54.1 The currency of payment shall be stated in the SCC.</p> <p>54.2 Where payments are to be made in currencies other than the Tanzania Shillings, the exchange rates to be used for calculating such amounts shall be the Bank of Tanzania exchange rate prevailing on the date of contract signature</p>		<p>54 Currencies</p>

55 Compensation Events

55.1 The following shall be Compensation Events:

- (a) The Employer does not give access to a part of the Site by the Site Possession Date as per GCC 28.1.
- (b) The Employer modifies the Schedule of Other Contractors in a way that affects the work of the Contractor under the Contract.

- (c) The Project Manager orders a delay or does not issue Drawings, Specifications, or instructions required for execution of the Works on time.
- (d) The Project Manager instructs the Contractor to uncover or to carry out additional tests upon work, which is then found to have no Defects.

(e) The Project Manager unreasonably does not approve a subcontract to be let.

(f) Ground conditions are substantially more adverse than could reasonably have been assumed before issuance of the Letter of Acceptance from the information issued to tenders (including the Site Investigation Reports), from information available publicly and from a visual inspection of the Site.

(g) The Project Manager gives an instruction for dealing with an unforeseen condition, caused by the Employer, or additional work required for safety or other reasons.

(h) Other contractors, public authorities, utilities, or the Employer does not work within the dates and other constraints stated in the Contract, and they cause delay or extra cost to the Contractor.

(i) The advance payment is delayed.

(j) The effects on the Contractor of any of the Employer's Risks.

(k) The Project Manager unreasonably delays issuing a Certificate of Completion.

(l) Other Compensation Events described in the Contract or determined by the Project Manager shall apply.

<p>55.2 If a Compensation Event would cause additional cost or would prevent the work being completed before the Intended Completion Date, the Contract Price shall be increased and/or the Intended Completion Date shall be extended. The Project Manager shall, upon consultation with Employer, decide whether and by how much the Contract Price shall be increased and whether and by how much the Intended Completion Date shall be extended.</p> <p>55.3 As soon as information demonstrating the effect of each Compensation Event upon the Contractor's forecast cost has been provided by the Contractor, it shall be assessed by the Project Manager, if agreed by the Employer, the Contract Price may be adjusted accordingly. If the Contractor's forecast is deemed unreasonable, the Project Manager in consultation with Employer shall adjust the Contract Price based on the Project Manager's own forecast.</p> <p>55.4 The Contractor shall not be entitled to compensation to the extent that the Employer's interests are adversely affected by the Contractor's not having given early warning or not having cooperated with the Project Manager.</p>		
<p>56.1 The Project Manager shall adjust the Contract Price if taxes, duties, and other levies are changed between the date 28 days before the submission of tenders for the Contract and the date of the last completion certificate. The adjustment shall be the change in the amount of tax payable by the Contractor, provided such changes are not already reflected in the Contract Price or are a result of GCC 50.</p> <p>56.2 In the event that the Laws Governing Taxes, Duties and other levies have changed between the signature date and the last completion certificate thereby affecting the Contract Price, the Employer and the Contractor, shall mutually adjust the contract price accordingly.</p>		<p>56 Effect of Changes in Tax Laws</p>

57 Price Adjustment

<p>57.1 If applicable and stated in SCG, the amounts payable to the Contractor, pursuant to GCC 53.1 may be adjusted in respect of the rise or fall in the cost of labor, Contractor's Equipment, Plant, materials, and other inputs to the Works, by applying to such amounts the formulae prescribed in this clause.</p>	<p>57.2 To the extent that full compensation for any rise in costs to the Contractor is not covered by the provisions of this or other clauses in the Contract, the unit rates and prices included in the Contract shall be deemed to include amounts to cover the contingency of such other rise of costs.</p>	<p>57.3 The adjustment to be applied to amount payable to the Contractor as certified in Payment Certificates shall be determined formulae for each of the currencies in which the Contract Price is payable. No adjustment is to be applied to work valued on the basis of Cost or current prices. The formulae shall be as follows;</p> $P_n = a + b \frac{L_n - L_o}{L_o} + c \frac{M_n - M_o}{M_o} + d \frac{E_n - E_o}{E_o} + \text{etc.}$	<p>where;</p> <p>P_n is a price adjustment factor to be applied to the amount in each specific currency for the payment of the work carried out in the subject month, where such variations and daywork are not otherwise subject to adjustment;</p>
--	---	---	---

<p>The value of net work done, certified by the Project Manager, in any monthly Interim or Final Certificate as payable by the Employer to the Contractor before deduction of any retention money shall be increased or decreased by an amount of 'F'.</p>	
<p>a is a constant, specified in the Appendix to Tender, representing the nonadjustable portion in contractual payments;</p> <p>b, c, d, etc., are weightings or coefficients representing the estimated proportion of each cost element (labor, materials, equipment usage, etc.) in the Works or sections thereof, net of Provisional Sums, as specified in the Appendix to Tender; the sum of a, b, c, d, etc., shall be one;</p> <p>Ln, Mn, Fn, etc., are the current cost indices or reference prices of the cost elements in the specific currency of origin for month "n," determined pursuant to Sub-Clause 57.5, applicable to each cost element; and</p> <p>Lo, Mo, Fo, etc., are the base cost indices or reference prices corresponding to the above cost elements at the date specified in Sub-Clause 57.5</p>	

<p>57.4 The sources of indices shall be those listed in the Appendix to Tender, as approved by the Engineer. Indices shall be appropriate for their purpose and shall relate to the Contractor's proposed source of supply of inputs on the basis of which his Contract Price and expected foreign currency requirements shall have been computed. As the proposed basis for price adjustment, the Contractor shall have submitted with his tender the tabulation of Weights and Source of Indices in the Appendix to Tender, which shall be subject to approval by the Engineer.</p>		
<p>where;</p> <p>The effective value P_c of work done which is to be subjected to increase or decrease shall be the difference between:</p> <p>(i) the amount which, in the opinion of the Project Manager, is due to the Contractor under Clause 45 (before deduction of retention money and before deducting sums previously paid on account) less:</p> <ul style="list-style-type: none"> • any amount for payment or repayment of any advance payment; • any amount for materials on site (if any); • any amounts for nominated sub-contractors (if any) • any amounts for any other items based on actual cost or current prices; or • any sums for increase or decreases in the Contract Price paid under this Sub-Clause and <p>(ii) the amount calculated in accordance with (i) above of this Sub-clause and included in the last preceding statement.</p>		

<p>57.5 The base cost indices or prices shall be those prevailing on the day 28 days prior to the latest date for submission of tenders. Current indices or prices shall be those prevailing on the day 28 days prior to the last day of the period to which a particular Interim Payment Certificate is related. If at any time the current indices are not available, provisional indices as determined by the Engineer will be used, subject to subsequent correction of the amounts paid to the Contractor when the current indices become available.</p>		
<p>57.6 If the Contractor fails to complete the Works within the time for completion prescribed under GCC 21.1 adjustment of prices thereafter until the date of completion of the Works shall be made using either the indices or prices relating to the prescribed time for completion, or the current indices or prices, whichever is more favorable to the Employer, provided that if an extension of time is granted pursuant to GCC 37.1 the above provision shall apply only to adjustments made after the expiry of such extension of time.</p>		
<p>57.7 The weightings for each of the factors of cost given in the Appendix to Tender shall be adjusted if, in the opinion of the Engineer, they have been rendered unreasonable, unbalanced, or inapplicable as a result of varied or additional work already executed or instructed under GCC49 or for any other reason.</p>		

<p>58.1 The Employer shall retain from each payment due to the Contractor the proportion stated in the SCC. The total amount of retention shall not exceed the amount specified in the SCC.</p> <p>58.2 On completion of the whole of the Works, half the total amount retained shall be repaid to the Contractor and the other half when the Defects Liability Period has passed and the Project Manager has certified that all Defects notified by the Project Manager to the Contractor before the end of this period have been corrected.</p> <p>58.3 On completion of the whole Works, the Contractor may substitute retention money with an "on demand" or unconditional Bank guarantee.</p>		<p>58 Retention</p>
--	--	---------------------

<p>60.1 The Contractor shall be paid a Bonus calculated at the rate per calendar day stated in the SCC for each day (less any days for which the Contractor is paid for acceleration) that the Completion is earlier than the Intended Completion Date. The Project Manager shall certify that the Works are complete, although they may not be due to be complete.</p>		<p>60 Bonus</p>
<p>59.1 The Contractor shall pay liquidated damages to the Employer at the rate per day stated in the SCC for each day that the Completion Date is later than the Intended Completion Date. The total amount of liquidated damages shall not exceed the maximum amount of performance security specified in the SCC. The Employer may deduct liquidated damages from payments due to the Contractor. Payment of liquidated damages shall not affect the Contractor's liabilities.</p> <p>59.2 If the Intended Completion Date is extended after liquidated damages have been paid, the Project Manager shall correct any overpayment of liquidated damages by the Contractor by adjusting the next payment certificate. The Contractor shall be paid interest on the overpayment, calculated from the date of payment to the date of repayment, at the rates specified in GCC 53.1</p> <p>59.3 Where the Project Manager, after assessment of work progress, upon satisfaction that the Contractor will not complete the works within the contract period, may issue a notice to the Contractor requiring the payment of liquidated damages pursuant to GCC 59.1</p> <p>59.4 If the Contractor has not corrected a defects within the time specified in the Employer's notice, the Employer will assess the cost of having the defect corrected, the Contractor will pay this amount, and a penalty for lack of performance calculated as described in GCC 46.1</p>		<p>59 Liquidated Damages</p>

<p>61.1 The Employer shall make advance payment to the Contractor of the amounts stated in the SCC by the date stated in the SCC, against provision by the Contractor of an Unconditional Bank Guarantee in a form and by a bank acceptable to the Employer in amounts and currencies equal to the advance payment. The Guarantee shall remain effective until the advance payment has been repaid, but the amount of the Guarantee shall be progressively reduced by the amounts repaid by the Contractor. Interest will not be charged on the advance payment.</p> <p>61.2 The Contractor is to use the advance payment only to pay for Equipment, Plant, Materials, and mobilization expenses required specifically for execution of the Contract. The Contractor shall demonstrate that advance payment has been used in this way by supplying copies of invoices or other documents to the Project Manager.</p> <p>61.3 The advance payment shall be repaid by deducting proportionate amounts from payments otherwise due to the Contractor, following the schedule of completed percentages of the Works on a payment basis. No account shall be taken of the advance payment or its repayment in assessing valuations of work done, Variations, price adjustments, Compensation Events, Bonuses, or Liquidated Damages.</p>		<p>61 Advance Payment</p>
<p>62.1 The Performance Security shall be provided to the Employer no later than the date specified in the Letter of Acceptance and shall be issued in an amount stated in the SCC and form and by a bank or surety acceptable to the Employer, and denominated in the types and proportions of the currencies in which the Contract Price is payable. The Performance Security shall be valid until a date 28 days from the date of issue of the Certificate of Completion in the case of a Bank Guarantee, and until one year from the date of issue of the Completion Certificate in the case of a Performance Bond.</p>		<p>62 Performance Securities</p>

<p>62.2 Where circumstances necessitate the amendment of the contract after signature, and such amendment is effected, the Employer shall require the Contractor to provide additional Performance Security to cover for any cumulative increase of more than ten percent of the Initial Contract Price.</p>		
<p>63.1 If applicable, the Dayworks rates in the Contractor's Tender shall be used for small additional amounts of work only when the Project Manager has given written instructions in advance for additional work to be paid for in that way.</p> <p>63.2 All work to be paid for as Dayworks shall be recorded by the Contractor on forms approved by the Project Manager. Each completed form shall be verified and signed by the Project Manager within two days of the work being done.</p> <p>63.3 The Contractor shall be paid for Dayworks subject to obtaining signed Dayworks forms.</p>		<p>63 Dayworks</p>
<p>64.1 Loss or damage to the Works or Materials to be incorporated in the Works between the Start Date and the end of the Defects Correction periods shall be remedied by the Contractor at the Contractor's cost if the loss or damage arises from the Contractor's acts or omissions.</p>		<p>64 Cost of Repairs</p>
<p>F. Discharge of the Contract</p>		

<p>65.1 The Contractor shall request the Project Manager to issue a certificate of Completion of the Works, and the Project Manager will so issue upon satisfaction that the work is completed.</p>		<p>65 Completion Certificate</p>
<p>66.1 When the Certificate of Completion is issued by the Project Manager, the Contractor shall handover the site and the works to the Employer within time specified in the SCC</p>		<p>66 Site Hand Over</p>
<p>67.1 Upon the expiry of the defect liability period, the Contractor shall supply the Project Manager with a detailed account of the total amount that the Contractor considers payable under the Contract. The Project Manager shall, within fifty six (56) days, verify the account and, upon satisfaction, certify any final payment due to the Contractor and thereafter issue a defect liability certificate.</p> <p>67.2 In the event the Project Manager is not satisfied with the Account submitted by the Contractor pursuant to sub-clause 67.1, shall within 56 days issue a schedule of correction. If the final account remains unsatisfactory after it has been re-submitted, the Project Manager shall, upon consultation with the Employer, decide on the amount payable to the Contractor and issue a payment certificate.</p>		<p>67 Final Account</p>
<p>68.1 The Contractor shall supply to the Employer the "as built" Drawings and/or operating and maintenance manuals and any other related documents by the handover period stipulated in the SCC pursuant to GCC 66</p> <p>68.2 If the Contractor does not supply the Drawings and/or manuals stated in GCC 68.1 by the dates specified pursuant to clause 66 of the GCC, or they do not receive the Project Manager's approval, the Project Manager shall withhold the amount stated in the SCC from payments due to the Contractor.</p>		<p>68 Operating and Maintenance Manuals</p>
<p>69.1 The Employer or the Contractor may terminate the Contract if the other party causes a fundamental breach of the Contract.</p>		<p>69 Termination</p>

<p>obstructive or fraudulent practices in competing for or in executing the Contract.</p> <p>For the purpose of this paragraph:</p> <p>“corrupt practice means the offering, giving receiving or soliciting of anything of value to influence the action of a public officer in the procurement process or contract execution;</p> <p>“coercive practice” means impairing or harming, or threatening to impair or harm directly or indirectly, any party or the property of the party for the purpose of influencing improperly the action or that party in connection with public procurement or in furtherance of corrupt practice or fraudulent practice;</p> <p>“collusive practices” means impairing or harming, or threatening to impair or harm directly or indirectly, any part or the property of the Party for the purpose of influencing improperly the action or a part or in connection with public procurement or government contracting or in furtherance of a corrupt practice or a Fraudulent Practice</p> <p>“fraudulent practice” means a misrepresentation of facts in order to influence a procurement process or the execution of a contract to the detriment of the Employer and includes collusive practices among tenderers, prior to or after submission designed to establish tender prices at artificial non-competitive levels and to deprive the employer of the benefits of free and open competition;</p> <p>“obstructive practice” means acts intended to materially impede access to required information in exercising a duty under this Contract;</p> <p>69.3 When either party to the Contract gives notice of a Fundamental breach of Contract to the other Party for a cause other than those listed under Sub-Clause 69.2 above, the Project Manager shall decide whether the said breach is</p>		
--	--	--

<p>69.4 Notwithstanding the above, the Employer may terminate the Contract for convenience.</p> <p>69.5 If the Contract is terminated, the Contractor shall stop work immediately, make the Site safe and secure, and leave the Site as soon as reasonably possible.</p>		
<p>70.1 If the Contract is terminated because of a fundamental breach of Contract by the Contractor, the Project Manager shall issue a certificate for the value of the work done and Materials ordered less advance payments received up to the date of the issue of the certificate and less the percentage to apply to the value of the work not completed as specified in the SCC. Additional Liquidated Damages shall not apply. If the total amount due to the Employer exceeds any payment due to the Contractor, the difference shall be a debt payable to the Employer.</p>		<p>70 Payment upon Termination</p>
<p>70.2 If the Contract is terminated for the Employer's convenience or because of a fundamental breach of Contract by the Employer, the Project Manager shall issue a certificate for the value of the work done, Materials ordered, the reasonable cost of removal of Equipment, repatriation of the Contractor's personnel employed solely on the Works, and the Contractor's costs of protecting and securing the Works, and less advance payments received up to the date of the certificate.</p>		

fundamental or not.

<p>71.1 All Materials on the Site, Plant, Equipment, Temporary Works, and Works shall be deemed to be the property of the Employer if the contract is terminated for fundamental breach by the Contractor,</p>	<p>72.1 In the event that the source of financing is suspended to the Employer, from which part of the payments to the Contractor are being made:</p> <p>(a) The Employer shall notify the Contractor of such suspension within seven (7) days of having received the financing agency's suspension notice.</p> <p>(b) After the Notice has been issued and within fourteen (14) days, the Parties shall mutually agree on the future events of the Contract</p>	<p>73.1 Neither Party shall have any liability or be deemed to be in breach of the Contract for any delay or other failure in performance of its obligations under the Contract, if such delay or failure is a result of an event of Force Majeure.</p> <p>73.2 For purpose of this clause, "Force Majeure" means an event which is beyond the reasonable control of a Party, is not foreseeable, is unavoidable, and its origin is not due to negligence or lack of care on the part of a Party, and which makes a Party's performance of its obligations hereunder impossible or so impractical as reasonably to be considered impossible in the circumstances, and includes, but is not limited to, war, riots, civil disorder, earthquake, fire, explosion, storm, flood, epidemics, or other adverse weather conditions, strikes, lockouts or other industrial action (except where such strikes, lockouts or other industrial action are within the power of the Party invoking Force Majeure to prevent</p> <p>73.3 If a Party (hereinafter referred to as "the Affected Party") is or will be prevented from performing its substantial obligation under the contract by Force Majeure, it shall give a Notice to the other Party giving full particulars of the event and circumstance of Force Majeure and the reasons for the event of Force Majeure preventing the Affected Party from, or delay the Affected Party</p>
<p>71 Property</p>	<p>72 Suspension of Financing</p>	<p>73 Force Majeure</p>

<p>73.4 The Affected Party shall use reasonable efforts to mitigate the effects of the event of Force Majeure and shall endeavour to minimise any delay in the performance of the contract as a result of Force Majeure;</p> <p>73.5 The Affected Party shall give Notice to the other Party when it ceases to be affected by the Force Majeure; and</p> <p>73.6 Upon completion of the event of Force Majeure and issuance Notice pursuant to GCC 73.3 the Affected Party must, as soon as reasonably practicable recommends the performance of its obligations under the contract. Where the Affected Party is the Contractor, the Contractor must provide a revised Work Program rescheduling the Works to minimise the effect of the prevention or delay caused by the event of Force Majeure.</p>		
<p>74.1 In the event the Affected Party have used all reasonable efforts to mitigate the effect of the event of force Majeure and minimize any delay in the performance of the contract as result of force Majeure, but the effect of force Majeure still subsist, the Project Manager upon written consent of the employer shall certify that the Contract has been frustrated.</p> <p>Upon certification by the Project Manager pursuant to GCC 74.1 the Contractor shall make the site safe and stop work as quickly as possible after receiving the certificate and shall be paid for all Works carried out.</p>		<p>74 Release from Performance</p>

VI. DRAWINGS

NO.	DESCRIPTION	DATE

REVISIONS

APPROVED BY: _____
 CHECKED BY: _____
 SCALES: 1:1

PROPOSED SOLID DRIFT TO BE BUILT AT
 INTERNATIONAL PARK.

DRAWING NO.

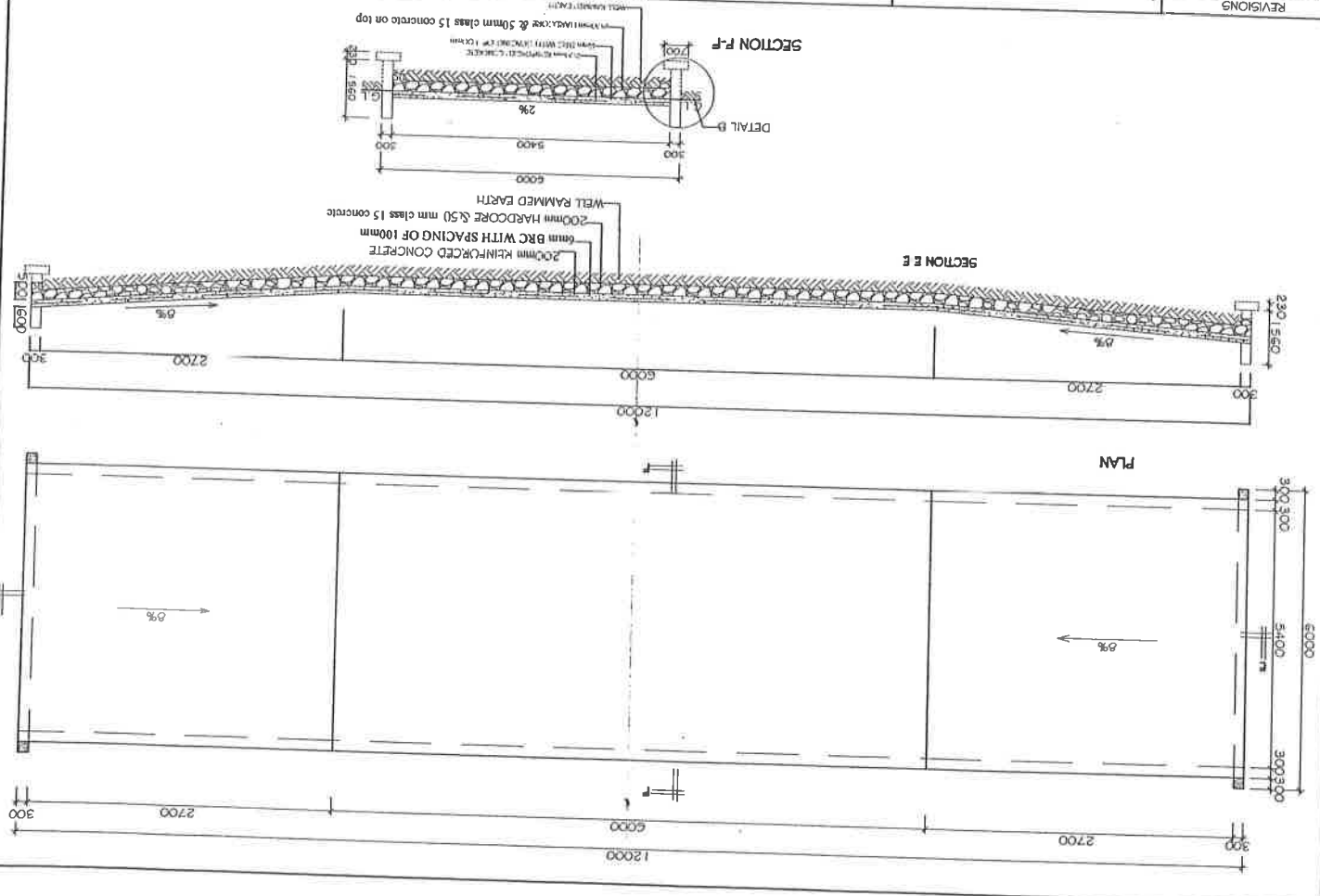

REVISIONS	
NO.	DESCRIPTION

DRAWING NO. 2	PROPOSED DETAIL B FOR TYPICAL CONCRETE POST	SCALES	1:1	CHECKED BY:	
		APPROVED BY:			

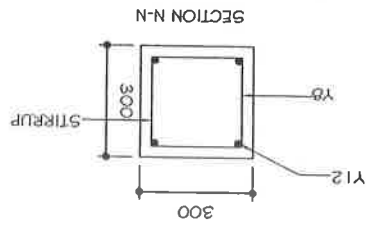
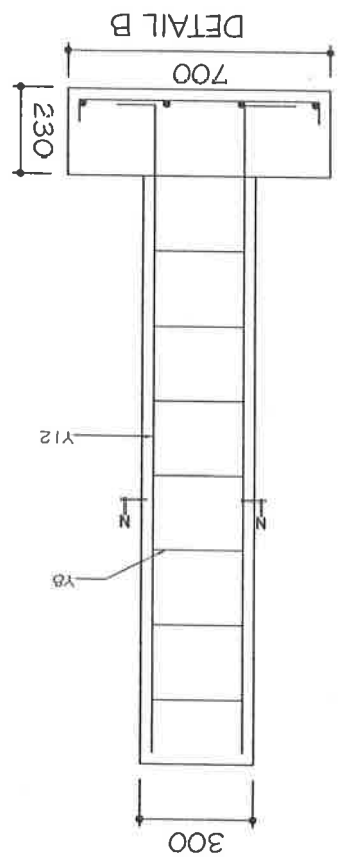

REVISIONS	
No.	DESCRIPTION

--	--

APPROVED BY:	
CHECKED BY:	

SCALES	1:1
--------	-----

PROPOSED PIPE CULVERTS TO BE BUILT AT NMF.

DRAWING 1
3

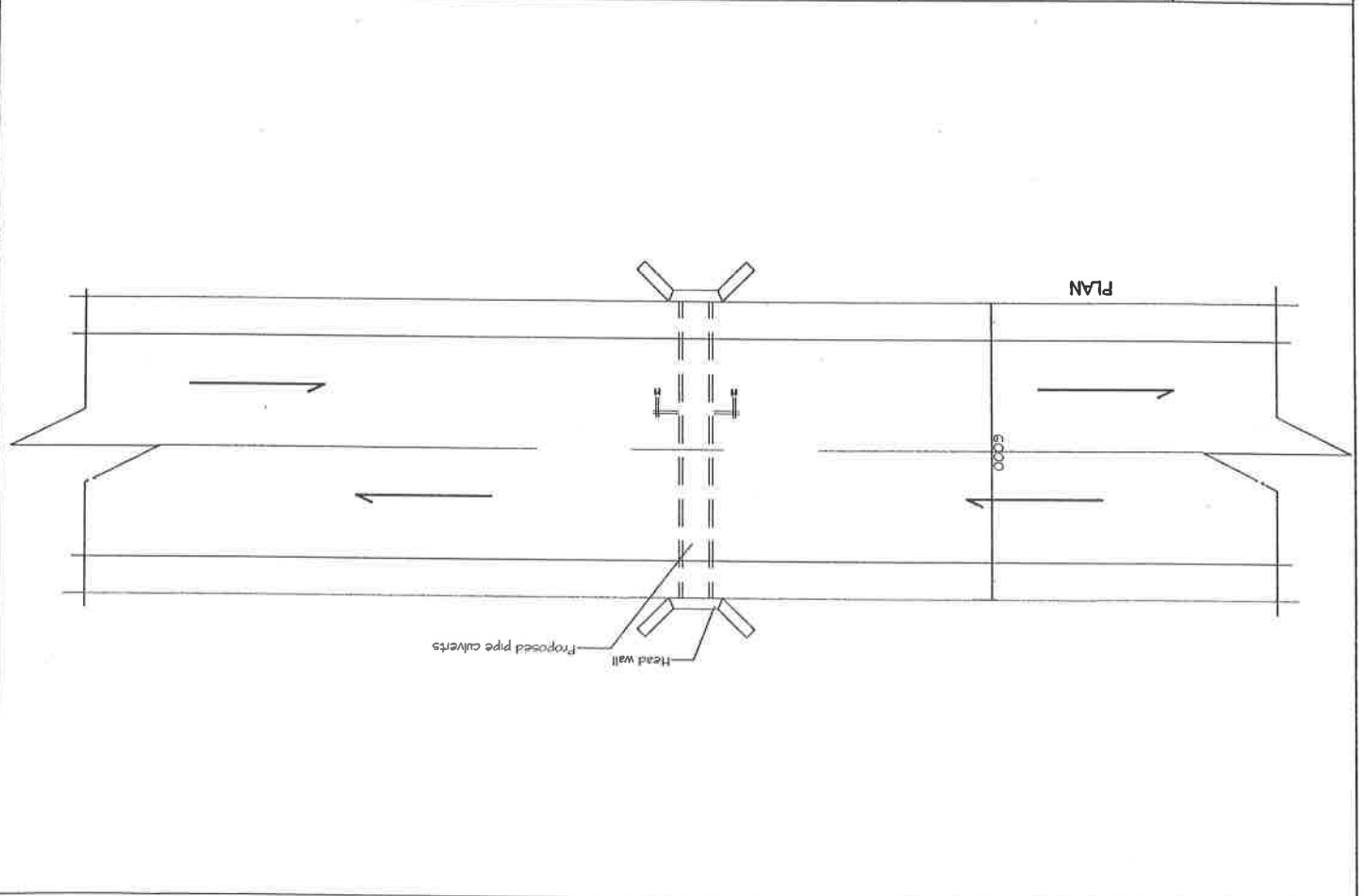

REV.	DESCRIPTION	DATE

TABLE OF DIMENSIONS (mm)

Pipe Diameter	No. of Opening	A	B	C	D	E
900	1	1300	2900	1400	1600	1600
900	2	2450	4050	1400	1600	1600

SINGLE CONCRETE PIPE CULVERT

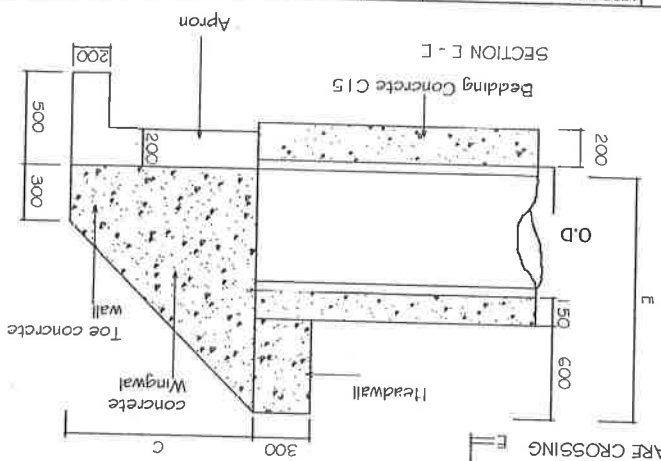
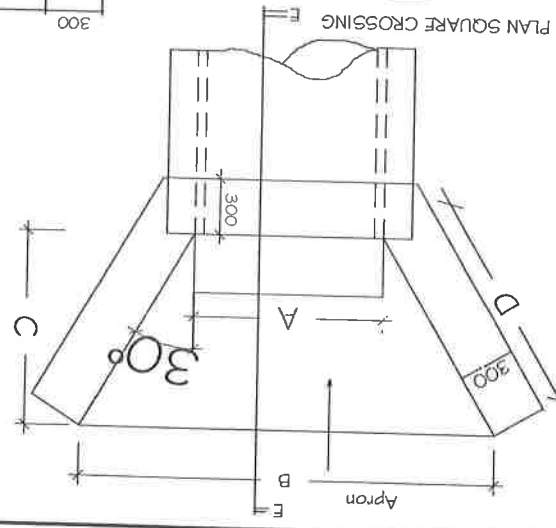
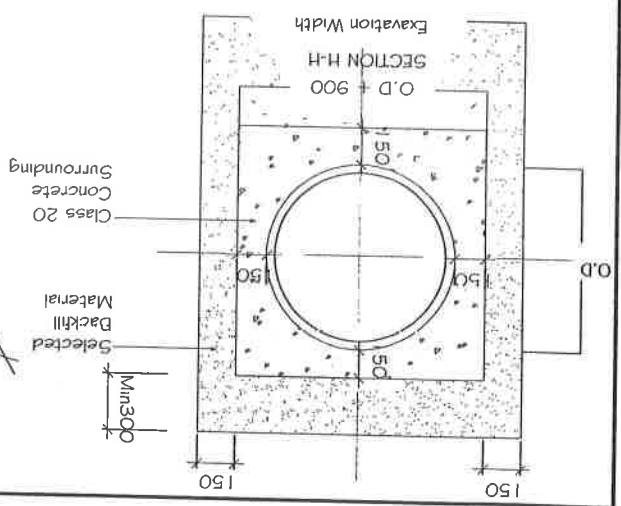

APPROVED BY: _____
CHECKED BY: _____
SCALES: 1:1
REPROCESSED PIPE CULVERTS TO BE BUILT AT MTRB/BL
DRAWING No. 4

VII. BILL OF QUANTITIES

BILL OF QUANTITIES FOR REHABILITATION OF LIMALE JUNCTION VIA NDEGERE-KIVUKO CHA MKANGIRA ROAD (130) KM IN NYERERE NATIONAL PARK.



Amount (Tsh)

Description of works		Unit	Qty	Rate(Tsh)	Amount (Tsh)
1 A:PRELIMINARIES&GENERAL ITEMS					
1.1	Laboratory testing	Ps	1	2,000,000	2,000,000.00
1.2	Allow for diversion	Is	1	3,000,000.00	3,000,000.00
1.3	Allow for establishment on site	Is	1	25,212,600.00	25,212,600.00
1.4	Mobilisation and demobilisation	Is	1	43,700,000.00	43,700,000.00
1.5	Project sign board	Is	1	2,500,000.00	2,500,000.00
Sub total for preliminaries					
					70,412,600.00
2 B: ROAD WORKS					
2.1	Road clearance : Remove all bushes, trees and grasses along the road 7m width	Km	130	1,209,180.00	157,193,400.00
2.2	Form up road by heavy reshaping 5m width	Km	130	2,469,530.00	321,038,900.00
Sub total for Road works					
					478,232,300.00
3 C: DRAINAGE WORKS					
3.1	Excavate mitre drains 1m wide x 1.5m deep trapezoidal shape	m	3,500	6,300.00	22,050,000.00
Sub total for drainage works					
					22,050,000.00
4 D: ROAD STRUCTURES:					
4.1 Solid drift 12m span					
a	Allow for testing of materials	ps	1	500,000.00	500,000.00
b	Site clearance	sqm	84.5	1,800.00	152,100.00
c	Excavation	cum	54	4,200.00	226,800.00
d	Lay stone of 200mm thick to receive BRC	cum	14.4	18,200.00	262,080.00
e	Placing 50mm thick concrete class 15 for blinding on well compacted ground	cum	4.5	245,000.00	1,102,500.00
f	Procure and fix fabric reinforcement (BRC 6mm) on well laid stone boulders	sqm	72	15,800.00	1,137,600.00
g	Install 200mm formwork made of marine board surrounding side beams, slab and alike	sqm	10	18,800.00	188,000.00
h	Lay concrete class 20 for slab 200mm deep and Guard post (reinforced and coloured black&white)	cum	14.4	267,000.00	3,844,800.00
i	contingency	Ps	1	1,020,000	1,020,000.00
Sub total					8,433,880.00
Total solid drift 12m span					25,301,640.00

67,412,600.00
150,000.00
40,700,000.00
20,212,600.00

3



[Handwritten signature]

4.2 Supply and install pipe culvert 900mm diameter as shown in the drawing				GRAND TOTAL (VAT INCLUSIVE)	
a	Allow for testing of materials	ps	1	200,000.00	200,000.00
b	Site Clearance	m ²	30	1,800.00	54,000.00
c	Excavation	m ³	20	4,200.00	84,000.00
d	placing 50mm thick concrete class 15 for blinding	m ³	1.2	245,000.00	294,000.00
e	Placing 200mm thick concrete class 20 for culvert base to receive reinforced culverts	m ³	3.5	267,000.00	934,500.00
f	Supply lay and join 900mm Ø Reinforced with 10mm H/Y steel bars ring culvert	m	6	220,000.00	1,320,000.00
g	Install 200mm formwork made of marine for concrete surrounding wing wall, head wall and the like	m ²	35	18,800.00	658,000.00
h	lay concrete class 20 for surrounding, wing walls, head walls and the like	m ³	7.5	267,000.00	2,002,500.00
i	different sizes for wing wall, head wall and the like				
j	! 12mmØ @200mm/c	kg	55	2,900.00	159,500.00
k	!! 6mmØ @200mm/c	kg	10	2,900.00	29,000.00
	150mm gravelling G25 for approach	m ³	30	45,000.00	1,350,000.00
	contingency	ps	1	1,850,000.00	1,850,000.00
	Sub total				8,935,500
	Total pipe culvert 900mm diameter as shown in the drawing	Nr	4	8,935,500	35,742,000
	Sub total for structure works				61,043,640
	Total amount				628,738,540
	Add VAT 18%				113,172,937.2
	GRAND TOTAL (VAT INCLUSIVE)				741,911,477.2



Description of works				Unit	Qty	Rate(Tsh)	Amount(Tsh)
1	A:PRELIMINARIES&GENERAL ITEMS						
1.1	Laboratory testing	Ps		1	2,000,000	2,000,000	
1.2	Allow for diversion	Is		1	3,000,000	3,000,000	
1.3	Allow for establishment on site	Is		1	20,212,600	20,212,600	
1.4	Mobilisation and demobilisation	Is		1	40,700,000	40,700,000	
1.5	Project sign board	Is		1	1,500,000	1,500,000	
Sub total for preliminaries							67,412,600
2	B: ROAD WORKS						
2.1	Road clearance : Remove all bushes, trees and grasses along the road 7m width	Km		130	1,209,180	157,193,400	
2.2	Form up road by heavy reshaping 5m width	Km		130	2,469,530	321,038,900	
Sub total for Road works							478,232,300
3	C: DRAINAGE WORKS						
3.1	Excavate mitre drains 1m wide x 1.5m deep trapezoidal shape	m		3,500	6,300	22,050,000	
Sub total for drainage works							
4	D: ROAD STRUCTURES:						
4.1	Solid drift 12m span						
	Allow for testing of materials	ps		1	500,000.00	500,000.00	
b	Site clearance	sqm		84.5	1,800	152,100.00	
c	Excavation	cum		54	4,200	226,800.00	
d	Lay stone of 200mm thick to receive BRC	cum		14.4	18,200	262,080.00	
e	Placing 50mm thick concrete class 15 for blinding on well compacted ground	cum		4.5	245,000	1,102,500.00	
f	Procure and fix fabric reinforcement (BRC 6mm) on well laid stone boulders	cum		72	15,800	1,137,600.00	
g	Install 200mm formwork made of marine board surrounding side beams, slab and alike	sqm		10	18,800	188,000.00	
h	Lay concrete class 20 for slab 200mm deep and Guard post (reinforced and coloured black&white)	cum		14.4	267,000	3,844,800.00	
i	contingency	Ps		1	1,020,000	1,020,000.00	
Sub total							8,433,880
Total solid drift 12m span				Nr	3	8,433,880	25,301,640.00

BILL OF QUANTITIES FOR MAINTENANCE OF LIMALE JUNCTION VIA NDEGERE-KIVUKO CHA MKANGIRA 130 KM IN NYERERE NATIONAL PARK:

VIII. FORMS OF SECURITIES

1. Performance Bank Guarantee [Unconditional]

[The bank/successful tenderer providing the Guarantee shall fill in this form in accordance with the instructions indicated in brackets, if the Employer requires this type of security.]

[insert bank's name, and address of issuing branch or office]

Beneficiary: [insert name and address of Employer]

Date: [insert date]

PERFORMANCE GUARANTEE No.: [insert Performance Guarantee number]

We have been informed that [insert name of Contractor] (hereinafter called "the Contractor") has been awarded a Contract No. [insert reference number of the Contract] dated with you, for the execution of [insert name of Contract and brief description of Works] (hereinafter called "the Contract").

Furthermore, we understand that, according to the conditions of the Contract, a performance guarantee is required.

At the request of the Contractor, we [insert name of Bank] hereby irrevocably undertake to pay you any sum or sums not exceeding in total an amount of [insert amount in figures] ([insert amount in words]), such sum being payable in the types and proportions of currencies in which the Contract Price is payable, upon receipt by us of your first demand in writing accompanied by a written statement stating that the Contractor is in breach of its obligation(s) under the Contract, without your needing to prove or to show grounds for your demand or the sum specified therein.

This guarantee shall expire no later than twenty-eight days from the date of issuance of the Taking-Over Certificate, calculated based on a copy of such Certificate which shall be provided to us, or on the [insert number day of insert month], [insert year], whichever occurs first. Consequently, any demand for payment under this guarantee must be received by us at this office on or before that date.

[signature(s) of an authorized representative(s) of the Bank]

2. Performance Bond

By this Bond, [insert name and address of Contractor] as Principal (hereinafter called "the Contractor") and [insert name, legal title, and address of surety, bonding company, or insurance company] as Surety (hereinafter called "the Surety"), are held and firmly bound unto [insert name and address of Employer] as Oblige (hereinafter called "the Employer") in the amount of [insert amount of Bond] [insert amount of Bond in words], for the payment of which sum well and truly to be made in the types and proportions of currencies in which the Contract Price is payable, the Contractor and the Surety bind themselves, their heirs, executors, administrators, successors, and assigns, jointly and severally, firmly by these presents.

Whereas the Contractor has entered into a Contract with the Employer dated the [insert number] day of [insert month], [insert year] for [insert name of Contract] in accordance with the documents, plans, specifications, and amendments thereto, which to the extent herein provided for, are by reference made part hereof and are hereinafter referred to as the Contract.

Now, therefore, the Condition of this Obligation is such that, if the Contractor shall promptly and faithfully perform the said Contract (including any amendments thereto), then this obligation shall be null and void; otherwise it shall remain in full force and effect. Whenever the Contractor shall be, and declared by the Employer to be, in default under the Contract, the Employer having performed the Employer's obligations there under, the Surety may promptly remedy the default, or shall promptly:

- (1) complete the Contract in accordance with its terms and conditions; or
- (2) obtain a Tender(s) from qualified tenderers for submission to the Employer and upon determination by the Employer and the Surety of the lowest responsive Tenderer, arrange for a Contract between such Tenderer and Employer and make available as work progresses (even though there should be a default or a succession of defaults under the Contract or Contracts of completion arranged under this paragraph) sufficient funds to pay the cost of completion less the balance of the Contract Price; but not exceeding, including other costs and damages for which the Surety may be liable hereunder, the amount set forth in the first paragraph hereof. The term "Balance of the Contract Price," as used in this paragraph, shall mean the total amount payable by the Employer to the Contractor under the Contract, less the amount properly paid by the Employer to the Contractor; or

(3) pay the Employer the amount required by the Employer to complete the Contract in accordance with its terms and conditions up to a total not exceeding the amount of this Bond.

The Surety shall not be liable for a greater sum than the specified penalty of this Bond.

Any suit under this Bond must be instituted before the expiration of one year from the date of issuance of the Certificate of Completion.

No right of action shall accrue on this Bond to or for the use of any person or corporation other than the Employer named herein or the heirs, executors, administrators, successors, and assigns of the Employer.

In testimony whereof, the Contractor has hereunto set its hand and affixed its seal, and the Surety has caused these presents to be sealed with its corporate seal duly attested by the signature of its legal representative, this [insert day] day of [insert month], [insert year].

Signed by [insert signature(s) of authorized representative(s)]
on behalf of [name of Contractor] in the capacity of [insert title(s)]

In the presence of [insert name and signature of witness]
Date [insert date]

Signed by [insert signature(s) of authorized representative(s) of Surety]
on behalf of [name of Surety] in the capacity of [insert title(s)]

In the presence of [insert name and signature of witness]
Date [insert date]

3. Bank Guarantee for Advance Payment

[Bank's Name, and Address of Issuing Branch or Office]

Beneficiary: _____ [Name and Address of Employer]

Date: _____

ADVANCE PAYMENT GUARANTEE No.: _____

We have been informed that [name of Contractor] (hereinafter called "the Contractor") has been awarded Contract No. [reference number of the contract] dated _____ with you, for the execution of [name of contract and brief description of Works] (hereinafter called "the Contract").

Furthermore, we understand that according to the conditions of the Contract, an advance payment in the sum [amount in figures] (—) [amount in words] is to be made against an advance payment guarantee.

At the request of the Contractor, we [name of Bank] hereby irrevocably undertake to pay you any sum or sums not exceeding in total an amount of [amount in figures] () [amount in words] upon receipt by us of your first demand in writing accompanied by a written statement stating that the Contractor is in breach of its obligation under the Contract because the Contractor used the advance payment for purposes other than the costs of mobilization in respect of the Works.

It is a condition for any claim and payment under this guarantee to be made that the advance payment referred to above must have been received by the Contractor on its account number _____ at _____ [name and address of Bank].

The maximum amount of this guarantee shall be progressively reduced by the amount of the advance payment repaid by the Contractor as indicated in copies of interim statements or payment certificates which shall be presented to us. This guarantee shall expire, at the latest, upon our receipt of a copy of the interim payment certificate indicating that eighty (80) percent of the Contract Price has been certified for payment, or on the _____ day of _____, 2____, whichever is earlier. Consequently, any demand for payment under this guarantee must be received by us at this office on or before that date.

Yours truly,

Signature and seal: _____

Name of Bank/Financial Institution: _____

Address: _____

Date: _____